

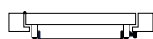

BARRA ANTIPANICO 1920

VC 5901

Nº Folhas



	Barra	Quadra	Acab. Suportes	Acab. Barra
208000010	900	8	Negro*	Verde*
208000011	900	8	Negro*	Negro*
208000013	900	8	Negro*	Cromado
208000014	900	8	Negro*	Inox
208000015	900	8	Satinado	Cromado
208000016	900	8	Satinado	Inox
208000017	900	8	Inox	Inox
208000018	900	8	Prata*	Prata*

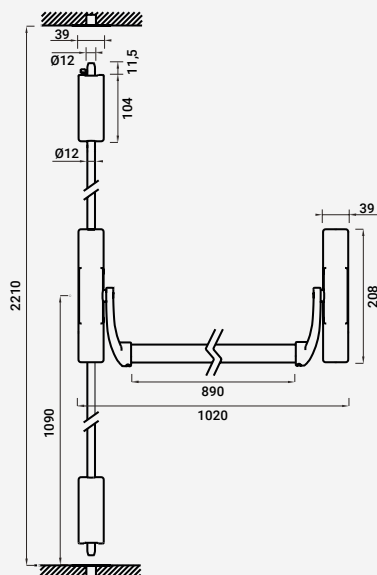

Dispositivos Antipânico
Tipologias

Nº Folhas

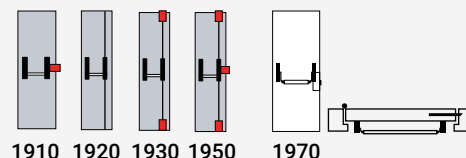

Nº Folhas

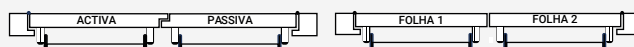

Sobrepôr com Batente

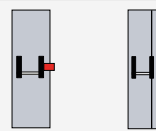

1910 1920

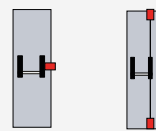

1910 1930

Sobrepôr sem Batente

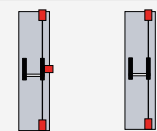

1950 1930

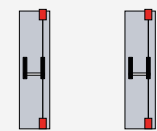

1930 1930

Embutir

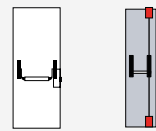

1970 1930

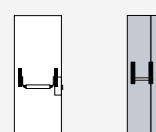

1970 1920

***ACABAMENTOS**

- Negro (RAL 9005)
- Verde (RAL 6002)
- Vermelho (RAL 3000)
- Cinza (RAL 9006)
- Branco (RAL 9010)