

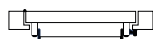

BARRA ANTIPANICO 1930

★ Inox Satinado

Nº Folhas



VC 5902



	Barra	Quadra	Acab. Suportes	Acab. Barra
208000019	900	8	Negro*	Verde*
208000020	900	8	Negro*	Negro*
208000021	900	8	Negro*	Vermelho*
208000022	900	8	Negro*	Cromado
208000023	900	8	Negro*	Inox
208000024	900	8	Satinado	Cromado
208000025	900	8	Satinado	Inox
208000026	900	8	Inox	Inox
208000027	900	8	Prata*	Prata*
208000028	900	8	Latonado	Latonado

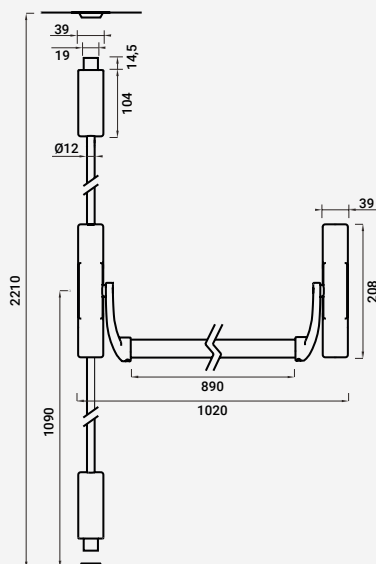

Dispositivos Antipânico
Tipologias

Nº Folhas

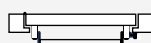

1910

1920

1930

1950

1970

Nº Folhas



Sobrepôr com Batente

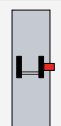

1910



1920

Sobrepôr sem Batente

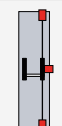

1950



1930

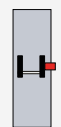

1910



1930

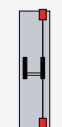

1930



1930

Embutir



1970



1930

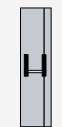

1920

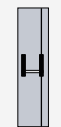

1920

***ACABAMENTOS**

Negro (RAL 9005)
Verde (RAL 6002)
Vermelho (RAL 3000)
Cinza (RAL 9006)
Branco (RAL 9010)